

Cleaning

All chrome surfaces should be cleaned using a clean damp cloth.

No abrasive cleaning agents or materials should be used.

General glass cleaner can be used for the screen, but ensure that this will not damage the chrome, check the cleaning information on the product before use.

This instruction will cover installation of the following units

Codes:

3381	6687	6688	7608
7609	7614	7756	8633
8786			

Telephone
0844 484 7678

Quadrant Shower Enclosure



Please retain this manual after installation for future reference and maintenance.

Images are for installation purposes only.



IMPORTANT

Handle with care, impact can damage both the glass and frame

Check for pipes and wires prior to drilling

Use of safety equipment is advised

Two people may be required for parts of the installation

Part	Code	Qty	Description
A1	P0029-2	2	Wall channel
A2	P0019-2	8	Wall plug
A3	P0002-6	8	Wall screw
A4	P0002-8	8	Profile to wall channel screw
A5		1	Drill bit
B1	P0030*	2	Fixed panel and profile
B2	P0002-9	8	Rail screws
C1	P0013 **	2	Panel vertical seal
D1	P0043 *	2	Door
D2	P0041-1	4	Top rollers
D3	P0001-8	4	Top roller covers
D4	P0041-2	4	Bottom spring loaded rollers
D5	P0001-9	4	Bottom roller covers
D7	P0042-1	2	Door handle
E1	P0065 *	1	Top rail
E2	P0065 *	1	Bottom rail
E3	P0034-2	4	Glass retainer
E4	P0002-12	4	Glass retainer screw
E5	P0013 **	1	Glass seal

* Full Code dependant on size of enclosure

** Full code dependant on thickness of glass

Seal the enclosure on the outside only, along the wall channel edge to the wall and along the bottom rail edge to the tray

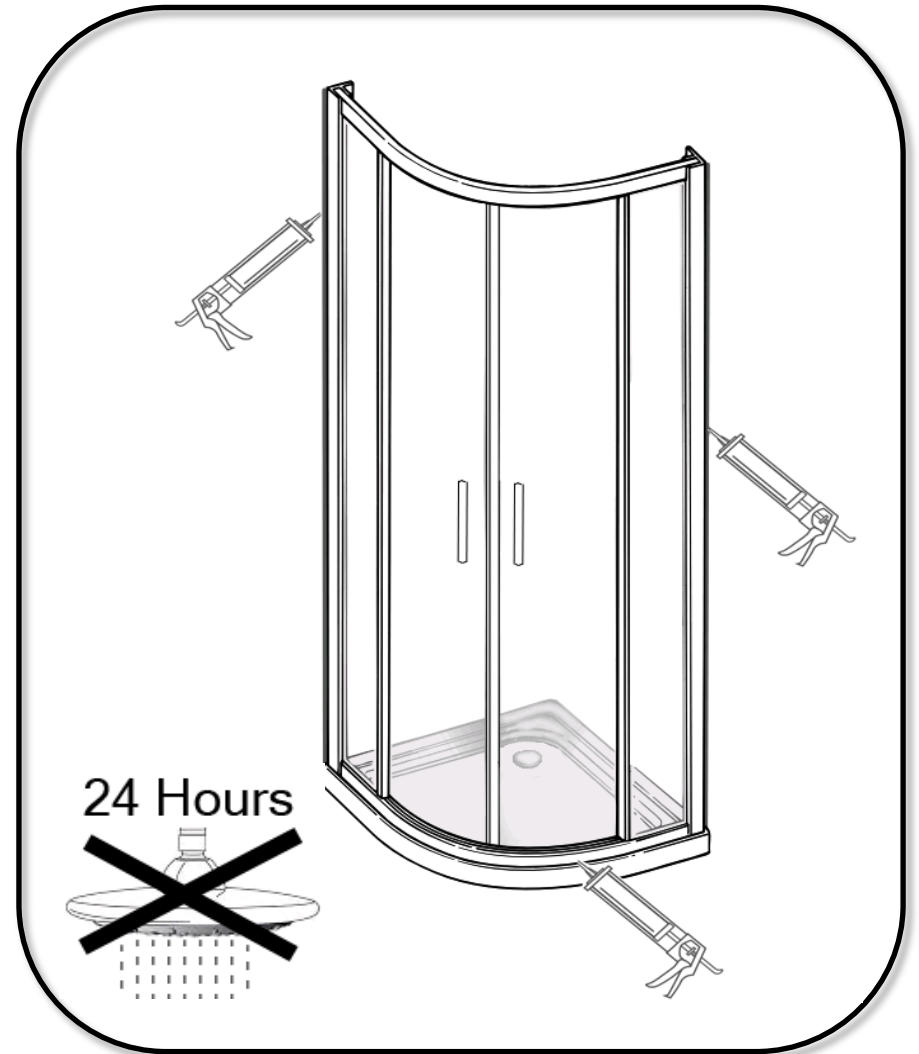

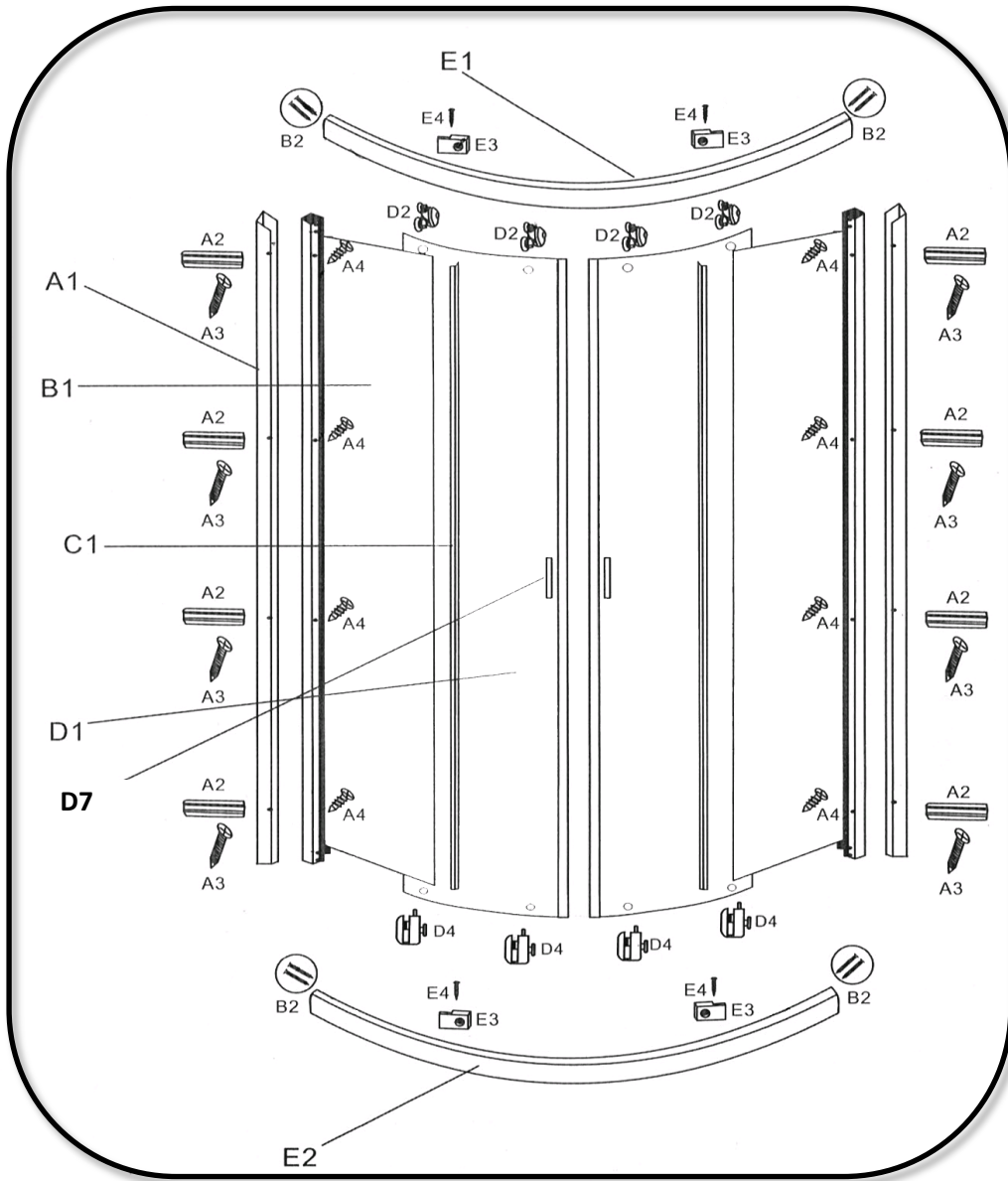









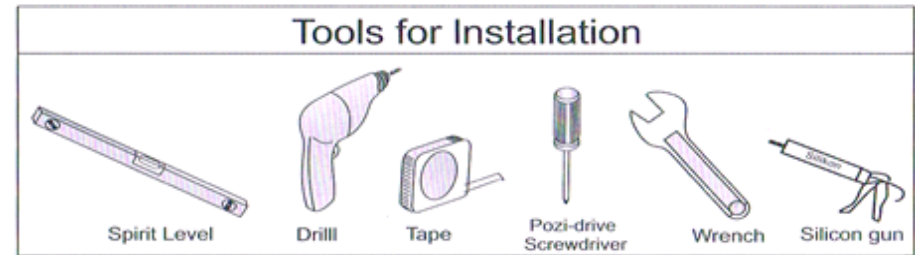
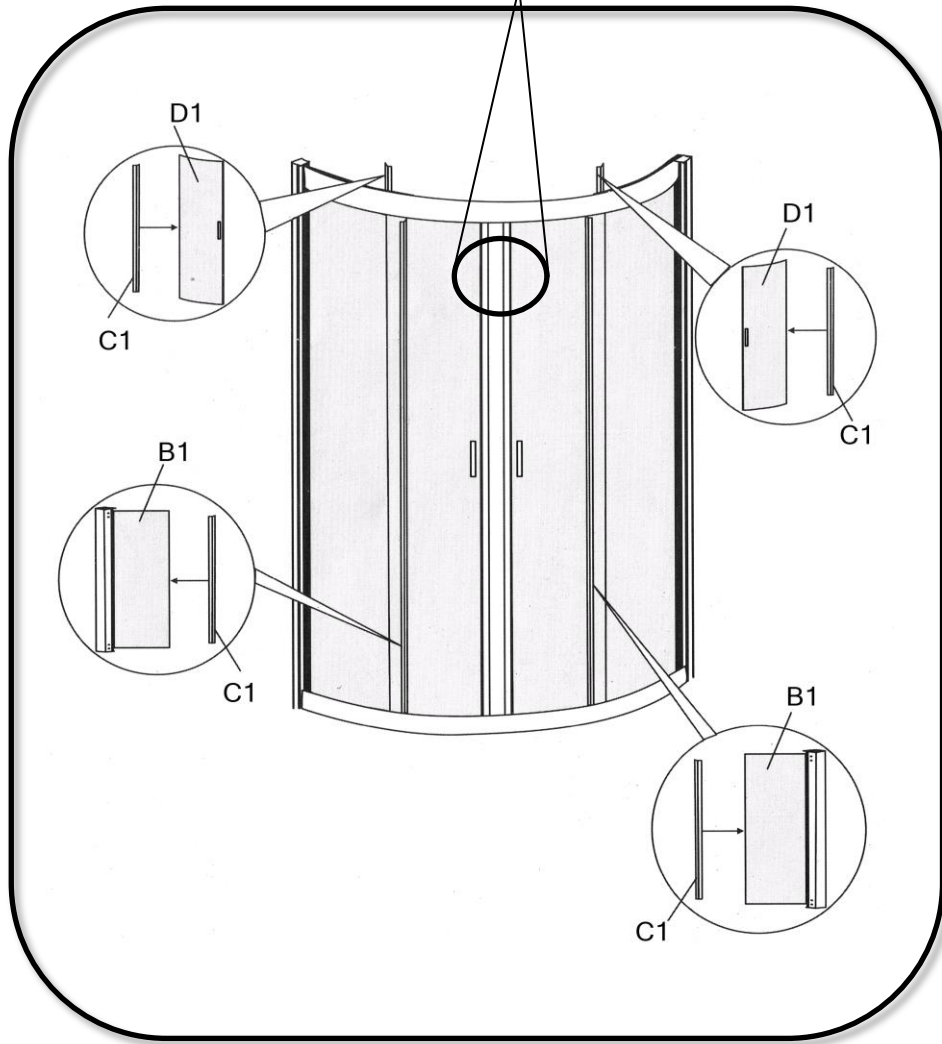











To fit the doors, hook the top rollers (D2) onto the top rail (E1) from inside.

Push the door (D1) towards to the bottom rail (E2), then press the spring loaded bottom roller (D4) to lift it into the bottom rail (E2)

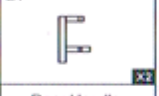

Push the glass seals (C1) on the glass where indicated below.
 If your version includes magnetic seals, push these onto the door edges



- | | | | | | |
|----------|--|--|--|---|---|
| A | A1

Wall channel x2 | A2

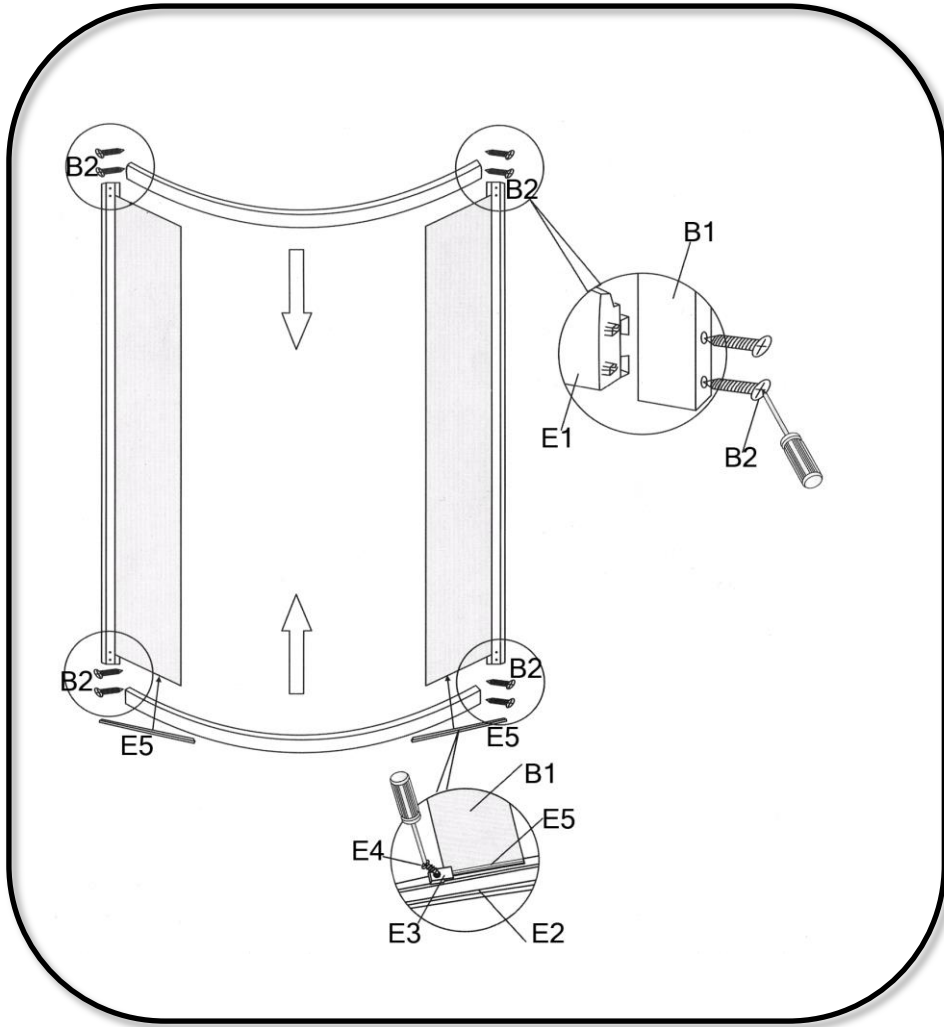
Plastic plug x10 | A3

M4x25 screw x10 | A4

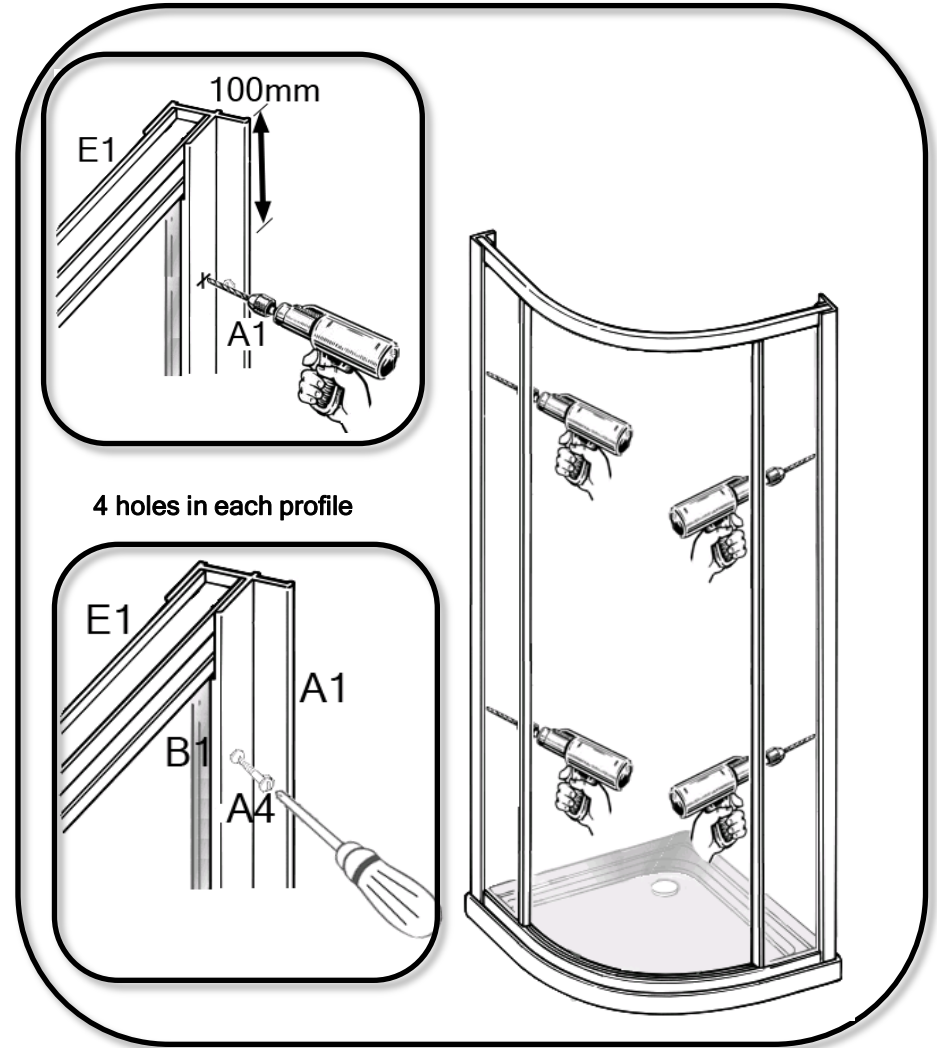
M4x10 screw x10 | A5

Masonary Drill x1 |
| B | B1

Panel upright & fixed Glass x2 | B2

M4x45 screw x10 | | | |
| C | C1

Seal x4 | | | | |
| D | D1

Door Glass x2 | D2

Top Roller x4 | D3

Cover for Top Roller x4 | D4

Bottom Roller x4 | D5

Cover for Bottom Roller x4 |
| | D7

Door Handle x2 | Bottom Spring Roller | | | |
| E | E1

Top Rail x1 | E2

Bottom Rail x1 | E3

Glass Retainer x4 | E4

M4x10 screw x6 | E5

Glass Seal x2 |

Insert the glass seal (E5) between fixed panel (B1) and bottom rail (E2)
Connect the top and bottom rails (E1 & E2) to the upright profile (B1) with
fixed glass panel, using screws (B2)
Fully tighten glass retaining brackets (E3) with screws (E4)



The enclosure then needs to be secured to the wall channels.
Drill the wall channel (A1) with the glass profile fitted, drill through the
channel and the profile, **DO NOT drill through both sides**, once
drilled secure using screws (A4)



Assemble the top fixed rollers (D2) to the glass door (D1),

Assemble the bottom spring rollers (D4) to the glass door (D1)

Secure the rollers using the screws in the rollers
Offer the door handle (D7) to the glass door (D1) and secure using fittings from inside.

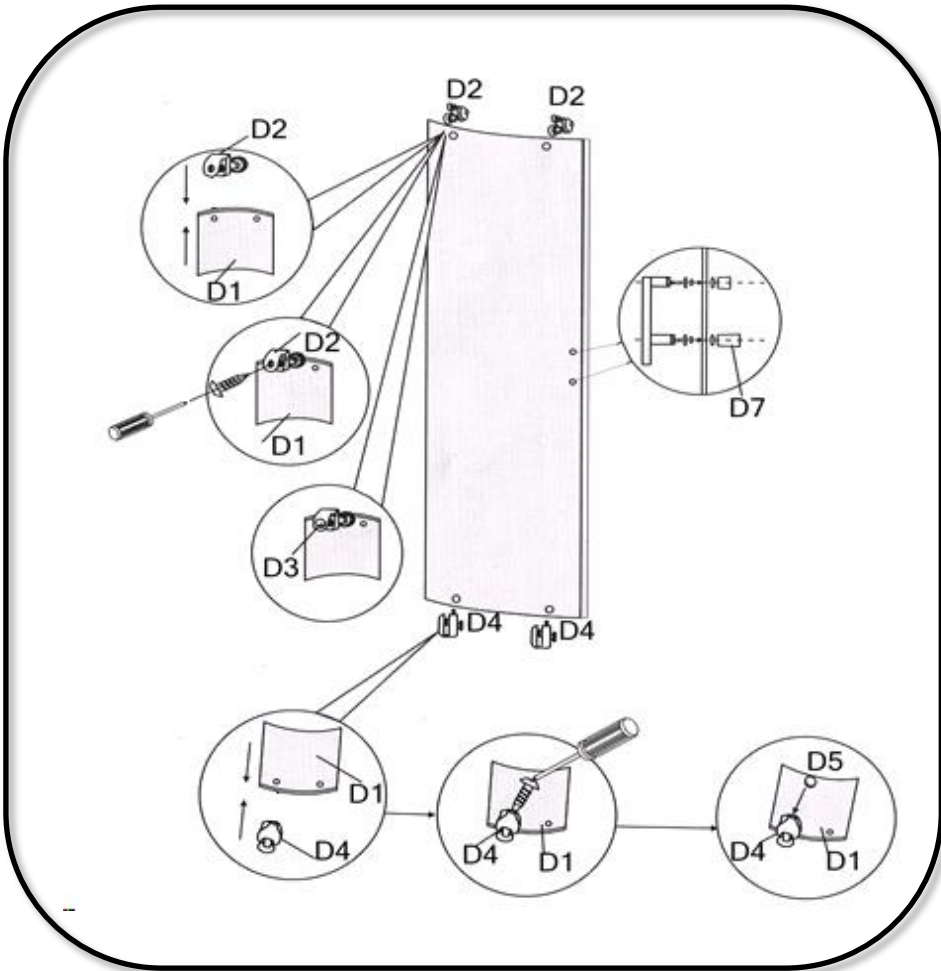

Install the glass retainers (E3) using screws (E4) into the top rail (E1) and bottom rail (E2)

Do not fully tighten at this stage

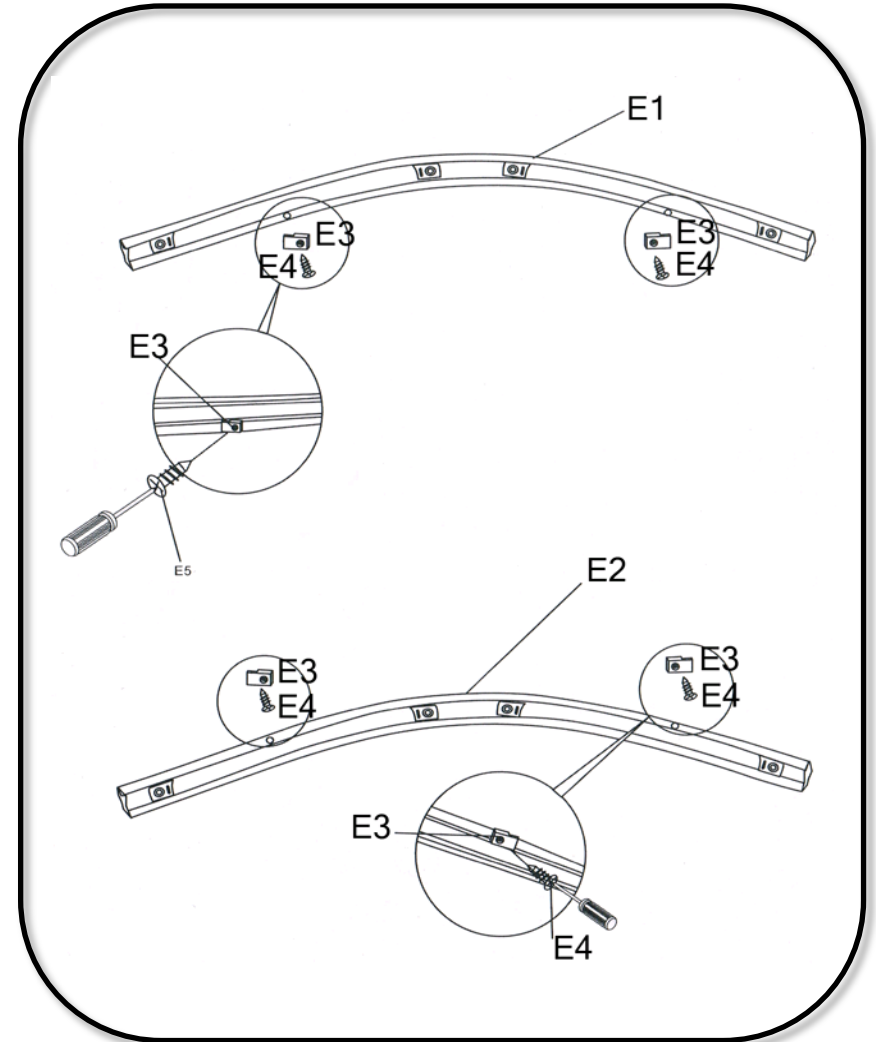

After drilling the holes, place the enclosure with wall channels back onto the tray and position over drill holes.

Once located secure using screws (A3)

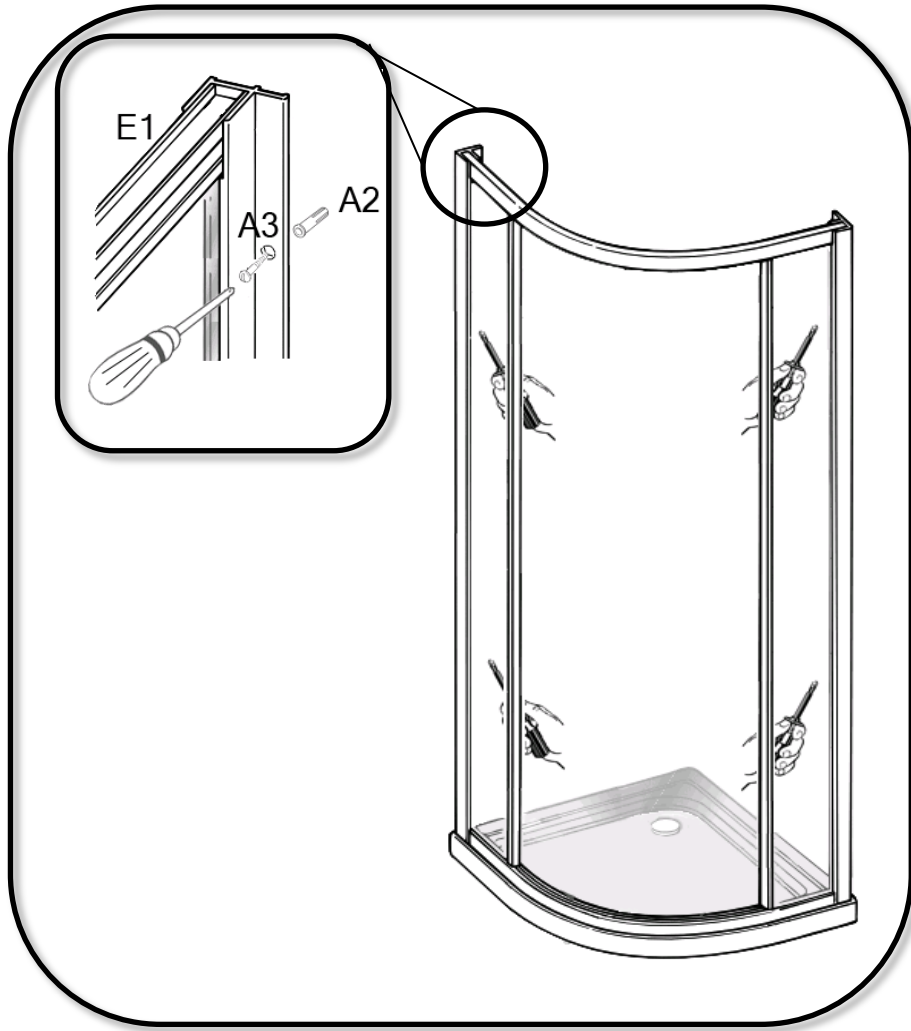

With rail and profiles assembled, push assembly into the wall channels (A1).

Place the whole assembly onto the tray and place against wall.

Level the assembly, using a spirit level and mark drill holes in wall channels.

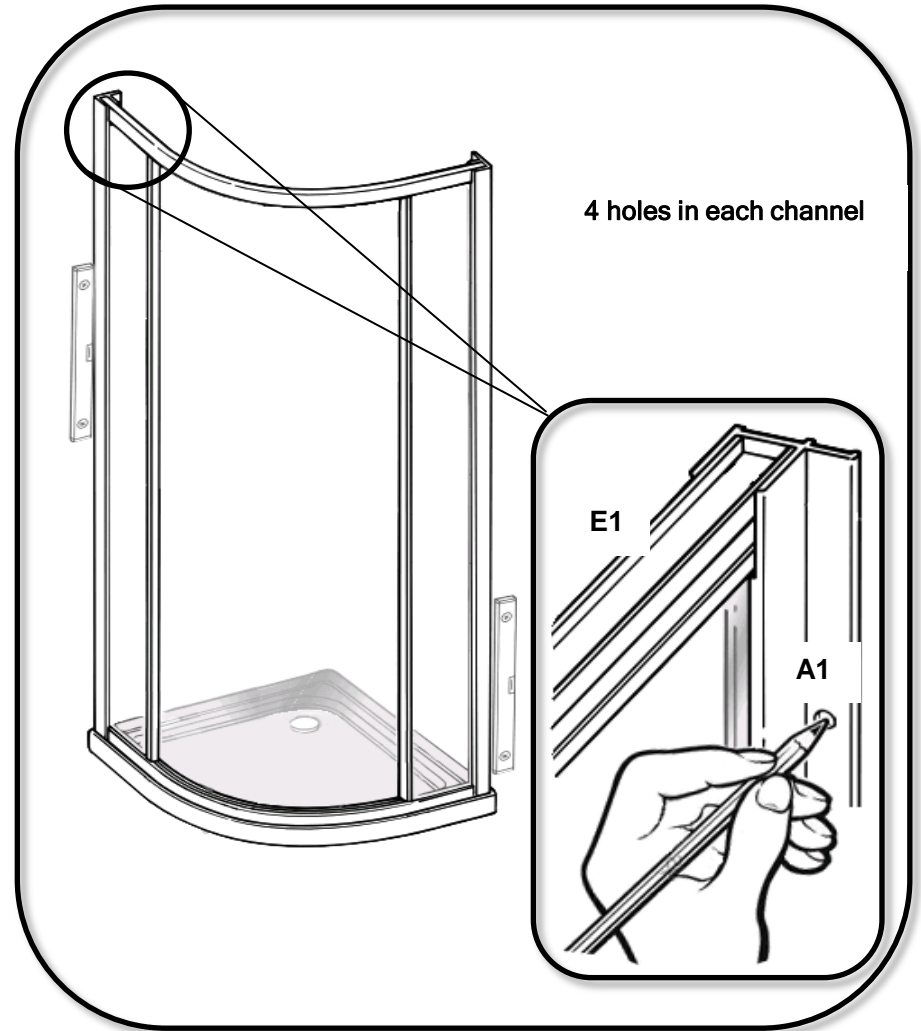

Guarantee

Your product comes with a 1 year guarantee when installed, used and cleaned in accordance with this manual.

Not covered by the guarantee is:

- Breakdown due to -
 - a) Use other than domestic
 - b) Wilful act of neglect
 - c) Any malfunction resulting from incorrect use
 - d) Incorrect assembly/installation
- Repair costs for damage caused by foreign objects or substances
- Total loss of the product due to non-availability of parts
- Compensation for loss of use of the product or consequential loss of any kind.
- Call out charges where no fault has been found with the product.

Your product comes with a 1 year guarantee when installed, used and cleaned in accordance with this manual.

Not covered by the guarantee is:

- The cost of repair or replacement of any accessories installed at the same time.
- The cost of routine maintenance, adjustments, overhaul, modifications, loss or damage, arising therefrom, including the cost of repairing damage, breakdown, malfunction caused by incorrect use, assembly or maintenance